

Spring Trampette

Ref. : 685

(UK) Assembly Instructions

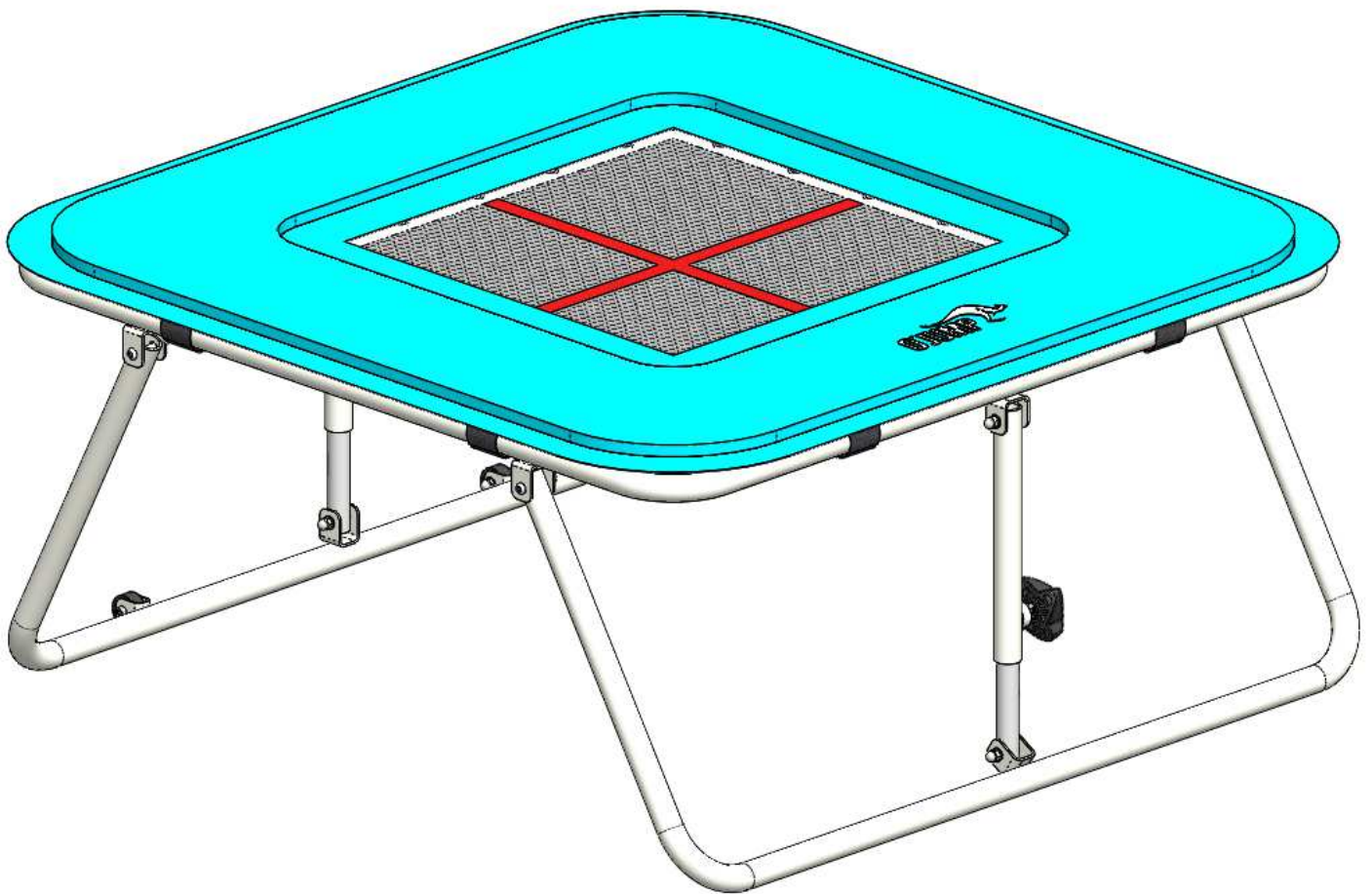

Thank you for buying this product O'jump. We advise you to read the assembly instructions carefully. The apparatus is presented in pre-assembled parts for a simplified assembly. We have designed this O'jump product to bring you complete satisfaction. If you need help, the O'jump team is at your disposal to accompany you.

 +33 (0)4 91 87 51 20
 +33 (0)4 91 93 86 89
 info@ojump.com

www.ojump.com

Warning:



This equipment must only be used by one person at a time and under the supervision of a qualified individual, with appropriate landing mats.

Using this equipment for purposes other than those originally intended is prohibited.

Recommendations:

- keep these instructions for subsequent reference (inspection, maintenance, etc.).
- periodically carry out predictive maintenance.
- depending on how much it is used, have the equipment serviced yearly or every few years.

Footprint and weight:







- Apparatus 120x120 cm 35Kg



Tools needed to assemble the apparatus.

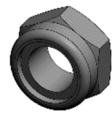

Hardware listing (pre-assembled)

- | | | | | |
|---|---|--|---|--|
| <p>A</p> <p>X2</p>  <p>Castor \varnothing38</p> | <p>B</p> <p>X2</p>  <p>M8 x 30</p> | <p>C</p> <p>X8</p>  <p>M8 x 40</p> | <p>D</p> <p>X10</p>  <p>\varnothing16x 8.5</p> | <p>E</p> <p>X10</p>  <p>M8</p> |
| <p>F</p> <p>X2</p>  <p>Indexing knob</p> | <p>G</p> <p>X28</p>  <p>Springs</p> | | | |



List of parts (pre-assembled)

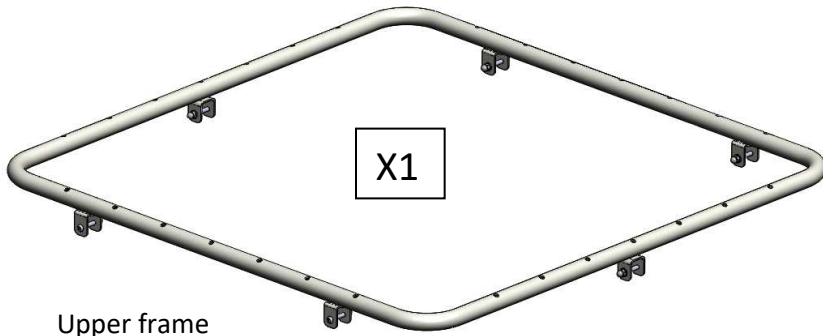

Upper frame

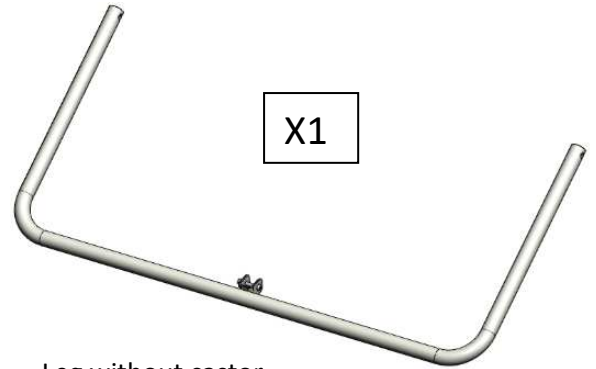

Leg without castor

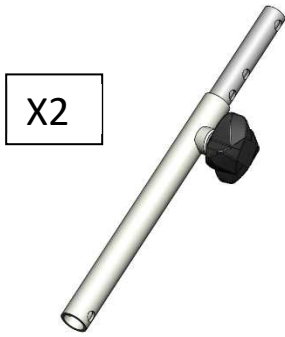

Sliding uprights

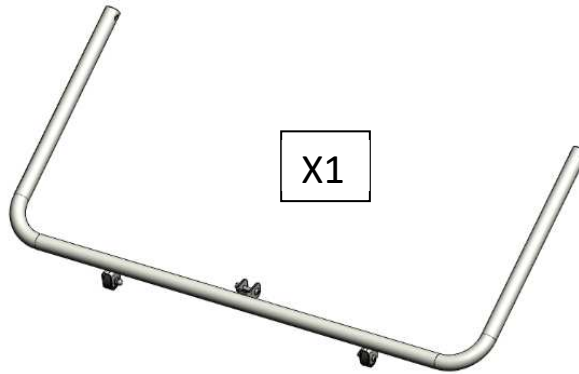

Leg with castors



Springs

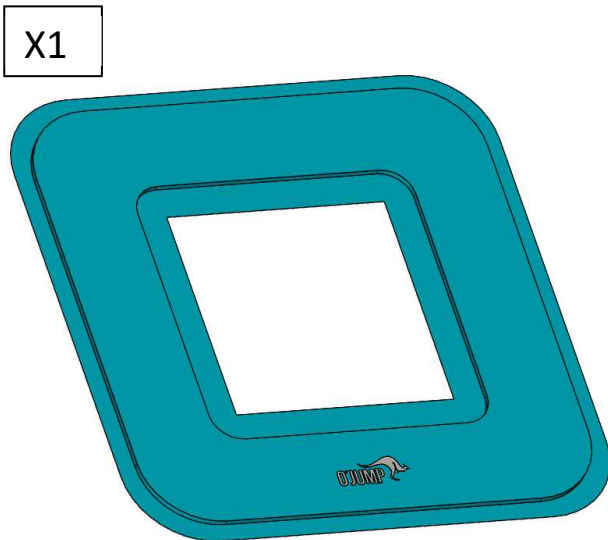

Protection

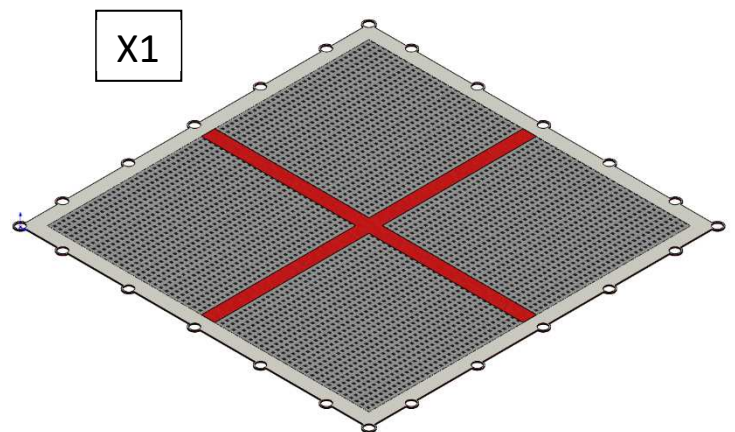

Bed

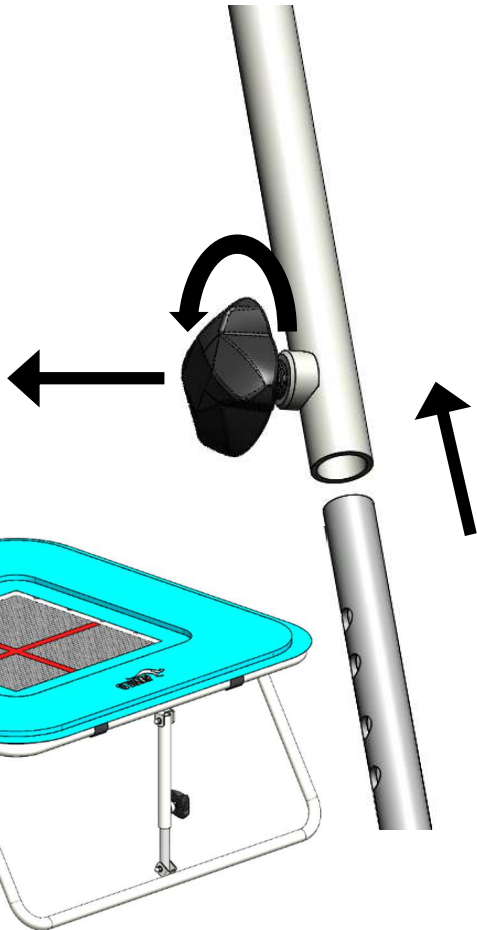
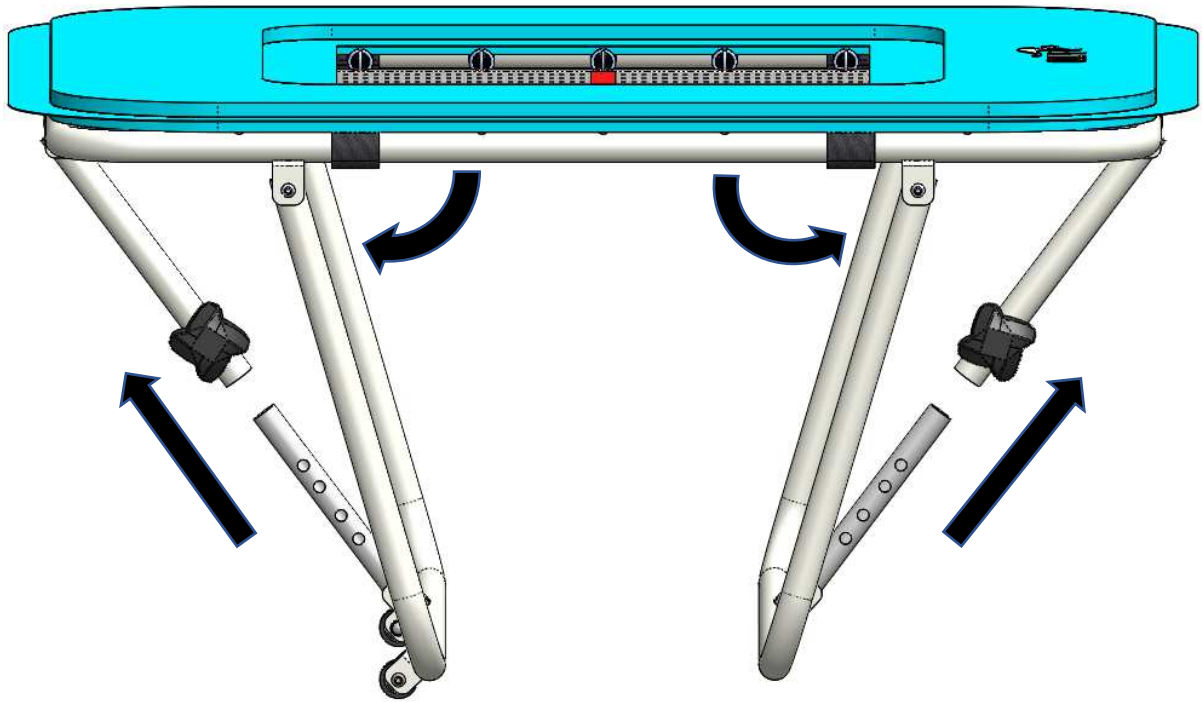

Unscrew and pull the indexing knob to release the slide.

Rotate the feet. Release the knob in front of the desired position. Lock the knob by tightening.

Repeat the operation for the other foot.

