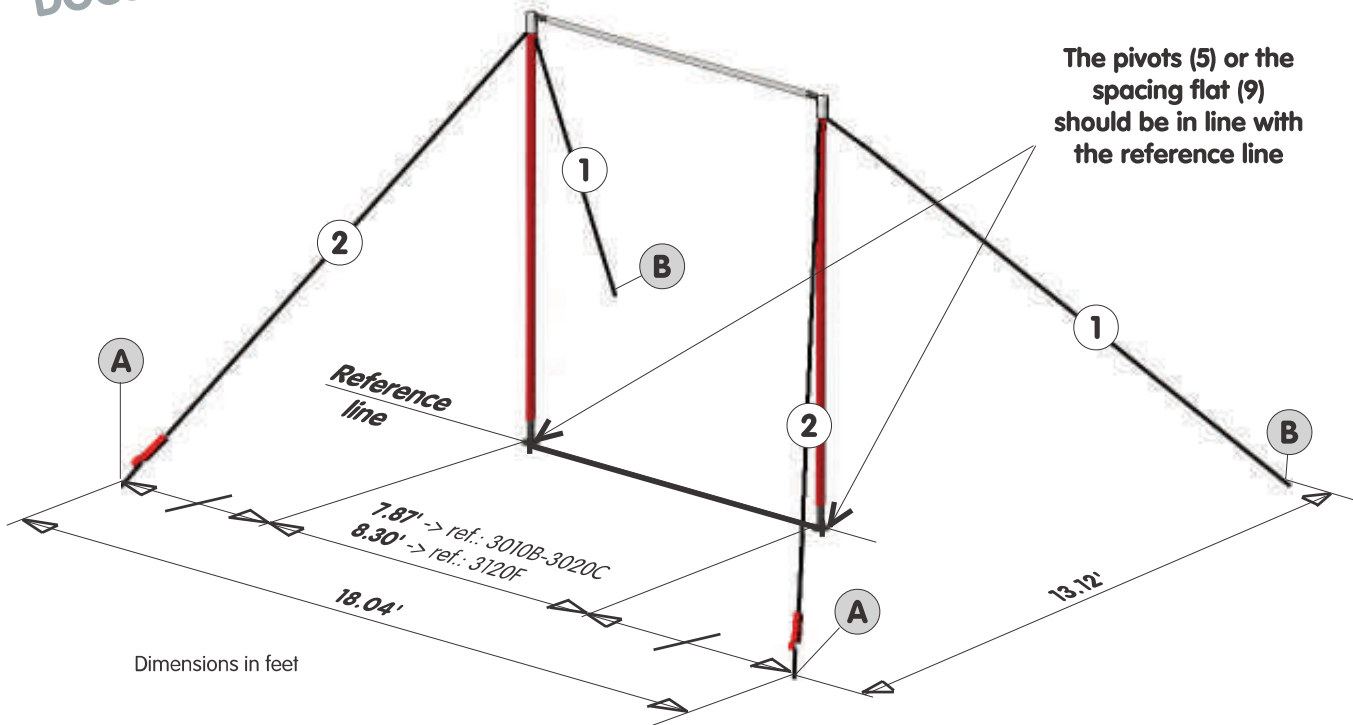

STANDARD CABLING M'2009
FOR HIGH BARS**3011B****KEEP THIS
DOCUMENT****Warning:**

This equipment should be installed by a qualified individual.

The apparatus should only be used by one person at a time, under the supervision of a qualified individual.

Using this equipment for purposes other than those originally intended is not allowed.

Attachments that are not provided with the apparatus may only be used if the support complies with the **CC34** specifications for GYMNOVA chemical anchors, (ref. : 2005 or ref. : 2010) or **CC22** for GYMNOVA retractable anchors, (ref. : 2000/40 - 2000/80).

Make sure that the quick links are closed and anchors are tightened before tightening the cables.

Do not use the equipment when the cables are slack.

Compliance:

This equipment complies with the requirements of the European standard EN 913 "Gymnastic equipment - General safety requirements and test methods".

Recommendations:

As shown in French Standard NF S52-400 the following is recommended:

- keep these instructions for subsequent reference (inspection, maintenance, etc.).
- periodically carry out predictive maintenance.
- depending on how much it is used, have the equipment serviced yearly or every few years.

Packaging:

1 Pack (ref.: 3011B)

Dimensions : 500 x 280 x 110 mm (19.7 x 11 x 4.33 in)

Masse : 9,4 kg (20.72 lb)

Volume : 0.0154 m³ (0.54 ft³)

I. Preparing the cables:

1 - Floor positioning (see Fig. 1 or 2):

- Plot the floor positioning of the anchors and the spacing flat (9) (or the distance between the pivots (5)).
- Drill in accordance with the assembly instructions **NM13** for chemical anchors or **NM25** for retractable anchors (for pivots (5): drill $\varnothing 12.45$ mm (1.77 in) deep, if required).

Important:

- The cable attachment points must resist 800 daN (see: NF S52-400).
- It is mandatory that **the uprights** are aligned with the reference line.

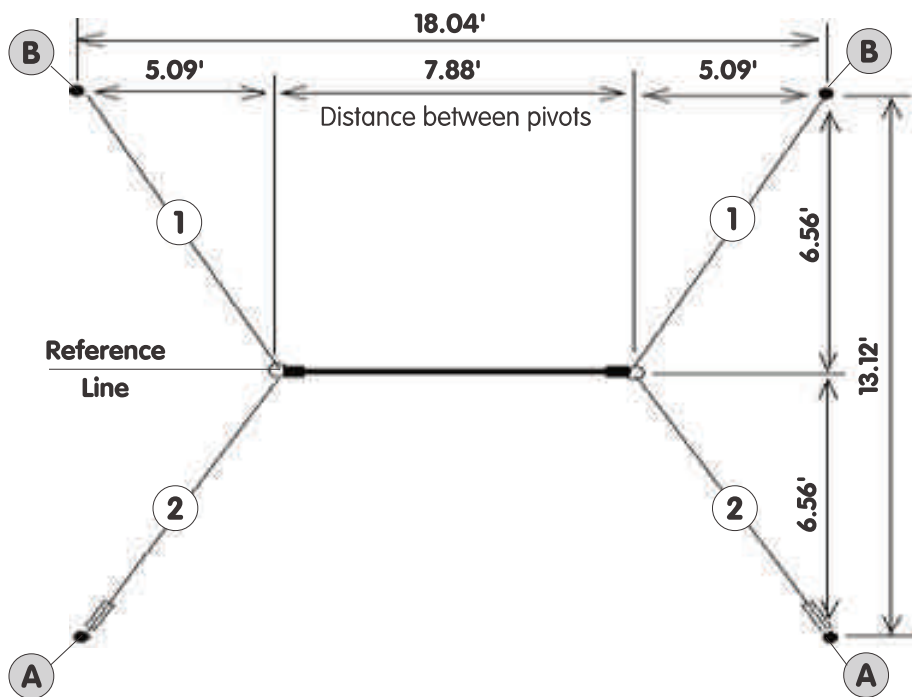
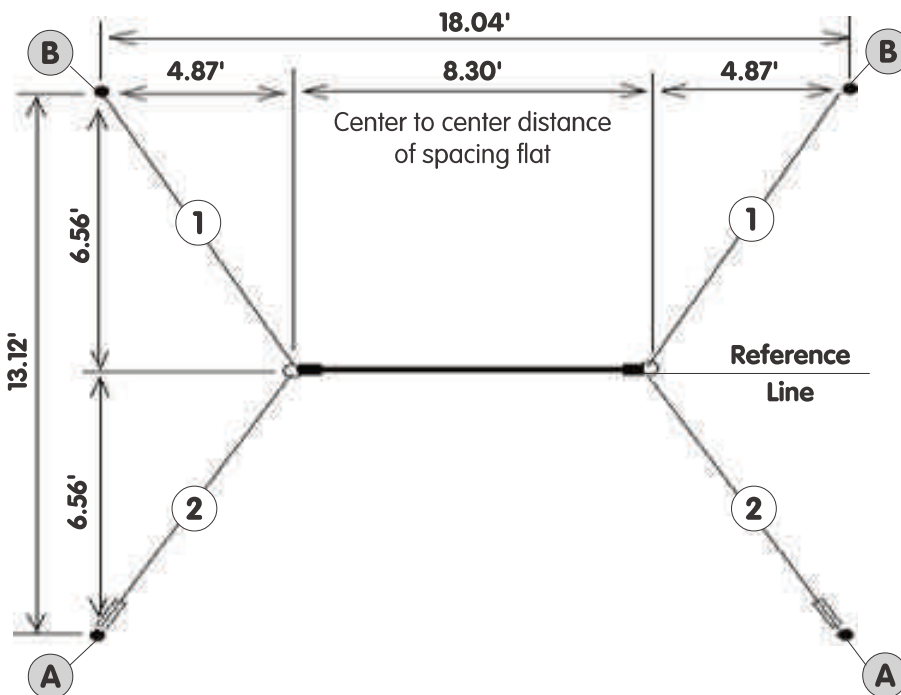

Figure 1
(Ref.: 3010B - 3020C)

Layout checking dimension:
22.31 ft diagonal

Figure 2
(Ref.: 3120F)



Dimensions in feet

2 - Layout of cabling items:

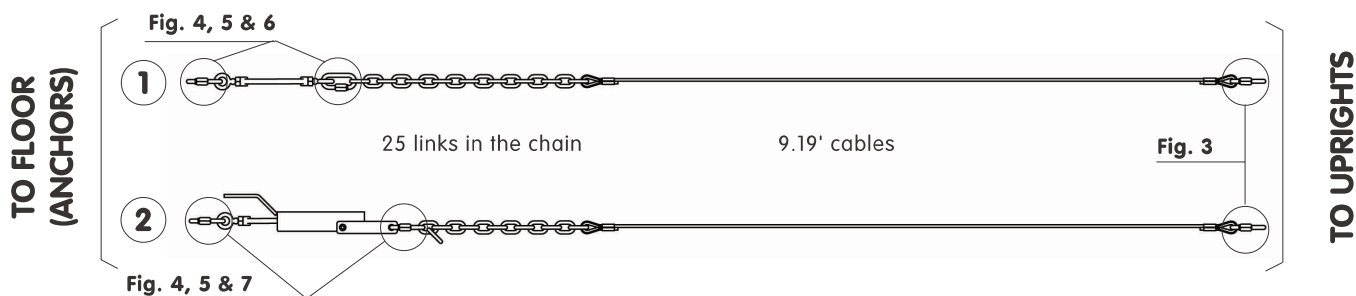

3 - Assembly principle and precautions:

- Make sure you assemble the quick links (3) in the proper direction (always tighten downward) like Fig. 3.
- Adjust the turnbuckles (8) to medium length to enable the cables to be adjusted easily like Fig. 6.

Note: Do not lock the floor attachments so that the bracing flats (6) can be positioned.

Figure 3 - quick link (3) / upright assembly

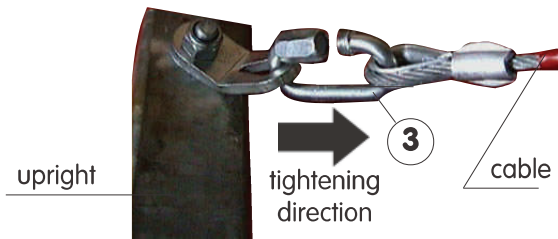

Figure 4 & 5 - quick link (3) / chain assembly

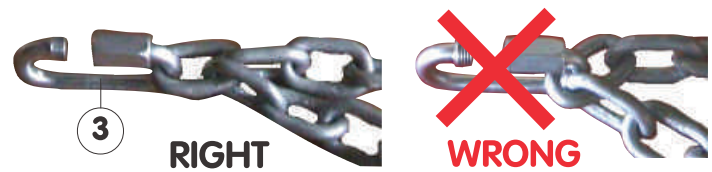
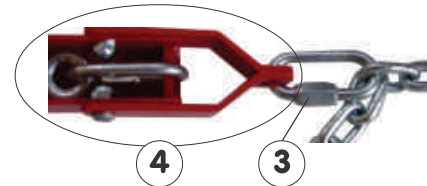

Figure 6 - quick link (3) / turnbuckle tie (8) assembly



Figure 7 - quick link (3) / quick tightener (4) assembly



II. Assembling the cables (minimum of 2 people required):

- Identify the location of each cable using Fig. 1 or 2 (on page 2) and the general view (on 1st page).
- Once the respective positions of the cables are determined, attach end of cables on all the uprights, using quick link (3), observing their assembly and tightening direction like Fig. 3.
- Hook the cables (1) to the rear anchors (B) using the quick links (3) setting chain lengths.
- Lift the high bar and set it into the pivots (5) or onto the spacing flat (9).
- Hold the apparatus and hook cables (2) to the front anchors (A) using the open quick tightener (4).
- Set each upright assembly vertical (use a level) by adjusting the chain links, then fine-tune the adjustments using the turnbuckles (8).

III. Adjusting and tightening the cables:

Important: Remember to lock all the floor attachments (7) before tightening the cables.

- 1 - To fine-tune the tension of cables (2), open the quick tightener (4) (see Fig. 9), screw or unscrew the turnbuckle (8). Lock the locknuts, then close the quick tightener (see Fig. 8).
- 2 - Position the handle of the quick tightener (4) so that it is above the turnbuckle (8).
- 3 - **Important:** Lock the quick links (3) and the locknuts on turnbuckles (4) and (8) using the wrench.

Figure 8 - Slack cabling: Open quick tightener

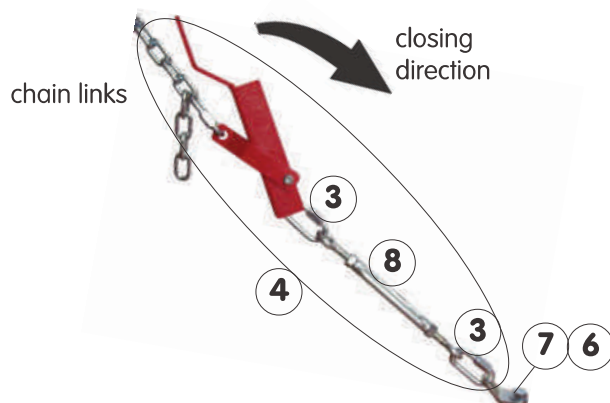
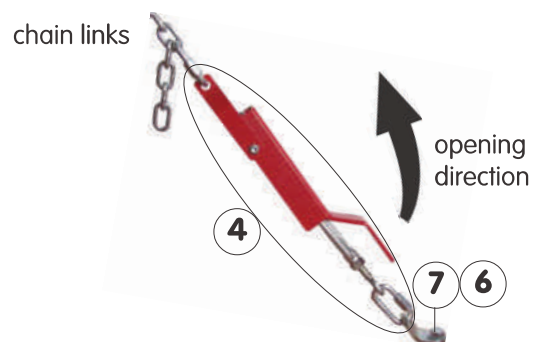

Figure 9 - Tightened cabling: Closed quick tightener



IV. Maintenance:

- 1 - A regular cleaning of the apparatus allows better viewing of the problems, if any (distortion, breakage, or corrosion).
- 2 - Before use, check wear parts and safety elements each time for good condition and operation: wear of cables, quick links (3), chain links, bracing flats (6), quick tighteners (4), and turnbuckles (8).
- 3 - Check the tightening of cables and closure of quick links, before each use.
- 4 - Check that the anchors (7) are locked and that they do not draw out from the floor.
- 5 - **Important:**
 - If a problem is detected or suspected, do not use the equipment as long as it has not been checked by a technician.
 - Any damaged or distorted piece should be replaced as soon as possible.

V. Storage:

Always store the equipment away from humidity and heat.

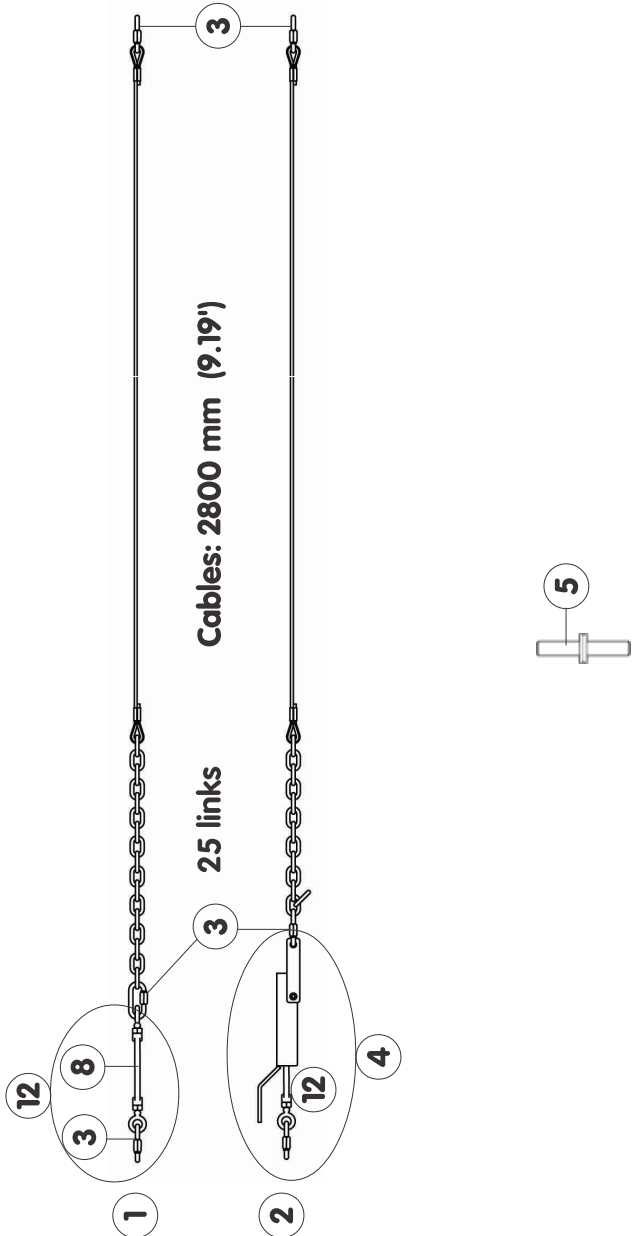

1	2
min: 10.48 Max: 13	min: 10.88 Max: 13.4
Adjustment range (ft)	

28	-	-	-	
27	-	-	-	
26	-	-	-	
25	-	-	-	
24	-	-	-	
23	-	-	-	
22	-	-	-	
21	-	-	-	
20	-	-	-	
19	-	-	-	
18	-	-	-	
17	-	-	-	
16	-	-	-	
15	-	-	-	
14	-	-	-	
13	-	-	-	
13	-	-	-	
12	4	M12 Turnbuckle + Quick link	QTELEMA812 each	
11	-	Share of 4 brac. flats+screws	3120/40 spare kit	
10	-	Share of 2 brac. flats+screws	3120/20 spare kit	
9	1	Spacing flat for training HB	312/03 not provided	
8	4	M12 O/O Turnbuckle tie	QTELEI012G each	
7	-	4 Anchors retract. hook	2000/40 not provided	
7	-	4 Chemical anchors bolt	2010 not provided	
6	4	Bracing flat	- not provided	
5	2	Support pivot	328/02 each	
4	2	Quick tightener	2550A spare kit	
3	10	Quick link No.8	QMRA00008Z each	
2	2	High Bar cable-tightener	3011/22 spare kit	
1	2	High Bar cable-turnbuckle	3011/21 spare kit	
ITEM	QTY	DESCRIPTION	REFERENCE	REMARKS

Gymnova
 RUE GASTON DE FLOTTE
 13012 MARSEILLE
 Tél. : 33-(0)-4-91-87-51-20
 Fax : 33-(0)-4-91-93-86-89

**STANDARD CABLING M'09
FOR HIGH BARS**

To order spare parts, provide the description, part no. and delivery date of the entire apparatus.